

e-Book



## Selecione o tópicos

■ CORES.....	03
■ MESAS.....	04
■ GAVETEIROS.....	09
■ ARMÁRIOS.....	15
■ PLATAFORMAS.....	23
■ COMPLEMENTOS.....	26

Cores disponíveis

Combinações de cores - Mesas, Gaveteiros, Armários e Plataformas

 <p>COR 1- 02 - CRISTAL COR 2- 02 - CRISTAL</p>	 <p>COR 1- 37 - NOGAL MALAGA COR 2- 05 - PRETO</p>	 <p>COR 1- 51 - CAST. VELASQUES COR 2- 05 - PRETO</p>	 <p>COR 1- 52 - FRES. SBIANCATTO COR 2- 05 - PRETO</p>	 <p>COR 1- 53 - LEGNO BLANCHE COR 2- 05 - PRETO</p>	 <p>COR 1- 54 - CARV. SMOKED COR 2- 05 - PRETO</p>	 <p>COR 1- 63 - IMBUIA TERRA COR 2- 05 - PRETO</p>
 <p>COR 1- 05 - PRETO COR 2- 05 - PRETO</p>	 <p>COR 1- 37 - NOGAL MALAGA COR 2- 07 - BRANCO</p>	 <p>COR 1- 51 - CAST. VELASQUES COR 2- 07 - BRANCO</p>	 <p>COR 1- 52 - FRES. SBIANCATTO COR 2- 07 - BRANCO</p>	 <p>COR 1- 53 - LEGNO BLANCHE COR 2- 07 - BRANCO</p>	 <p>COR 1- 54 - CARV. SMOKED COR 2- 07 - BRANCO</p>	 <p>COR 1- 63 - IMBUIA TERRA COR 2- 07 - BRANCO</p>
 <p>COR 1- 07 - BRANCO COR 2- 07 - BRANCO</p>	 <p>COR 1- 37 - NOGAL MALAGA COR 2- 37 - NOGAL MALAGA</p>	 <p>COR 1- 51 - CAST. VELASQUES COR 2- 51 - CAST. VELASQUES</p>	 <p>COR 1- 52 - FRES. SBIANCATTO COR 2- 52 - FRES. SBIANCATTO</p>	 <p>COR 1- 53 - LEGNO BLANCHE COR 2- 53 - LEGNO BLANCHE</p>	 <p>COR 1- 54 - CARV. SMOKED COR 2- 54 - CARV. SMOKED</p>	 <p>COR 1- 63 - IMBUIA TERRA COR 2- 63 - IMBUIA TERRA</p>

 Instrução de Cores

**Mesas:**

COR 1 - Tampos  
COR 2 - Pés Laterais e Saias

**Gaveteiros:**

COR 1 - Tampos e Frentes de Gaveta  
COR 2 - Caixaria

**Armários:**

COR 1 - Tampos e Portas de Armários  
COR 2 - Caixaria  
(Rodapé sempre na cor Alumínio)

**Plataformas:**

COR 1 - Tampos  
COR 2 - Pés Laterais e Saias

Molduras de caixas de tomada nas cores:

Preto: Quando os pés forem na cor Preto  
Branco: Quando os pés forem na cor Branco  
Alumínio: Quando os pés forem em qualquer outra cor



# MESAS

Sumário (selecione o item) 

Mesas.....	05
Mesa Reta.....	05
Mesa Auxiliar.....	05
Mesa Auxiliar Volante.....	05
Mesa Aparador.....	05
Mesa de Centro.....	06
Mesa Lateral.....	06
Mesa Diretor.....	06
Conjunto Mesa em L.....	06
Mesa Reunião Retangular.....	07
Mesa Reunião Retangular Bipartida.....	07
Mesa Diretiva para Gaveteiro Pedestal.....	08
Mesa Diretiva para Armário.....	08

### Mesa Reta

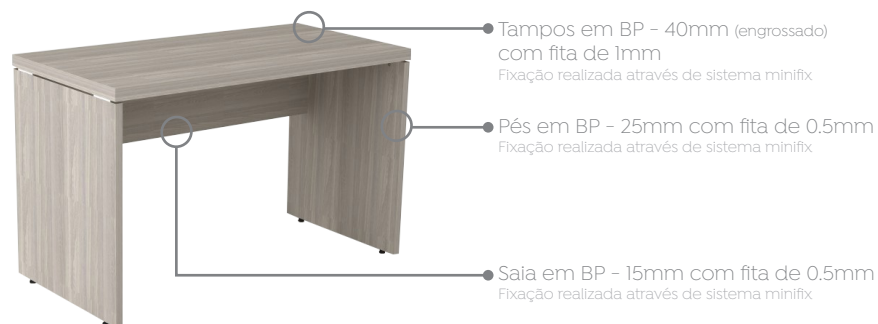

### Mesa Auxiliar Volante

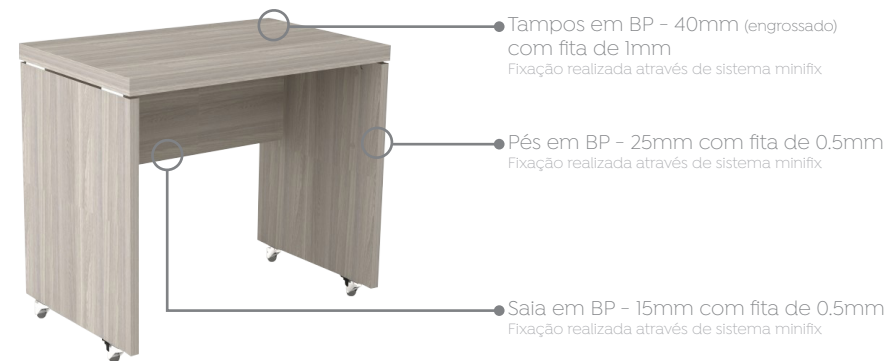

### Mesa Auxiliar

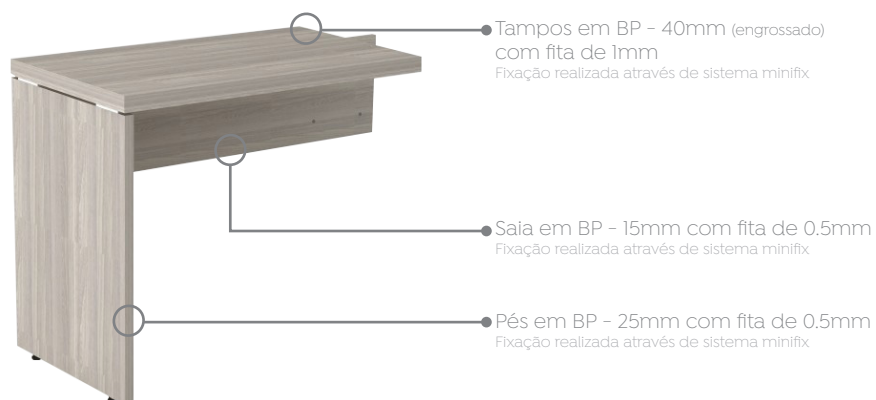

### Mesa Aparador

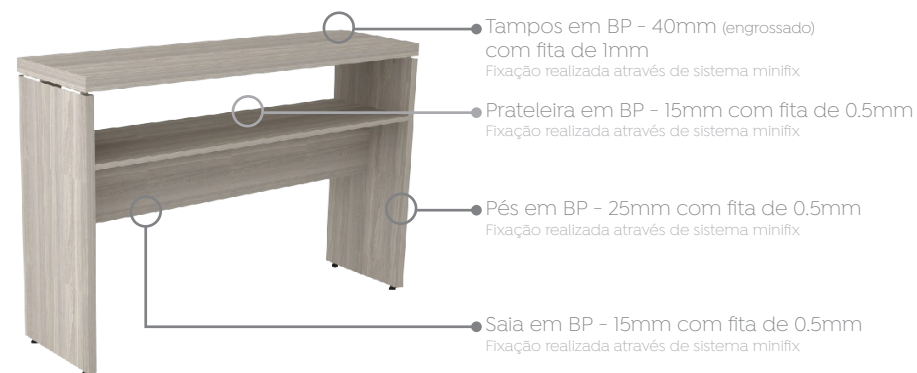

### Mesa de Centro



### Mesa Diretor



### Mesa Lateral

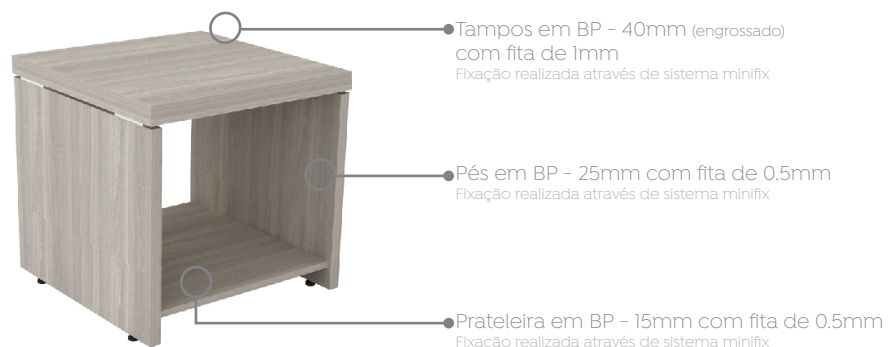

### Conjunto Mesa em L

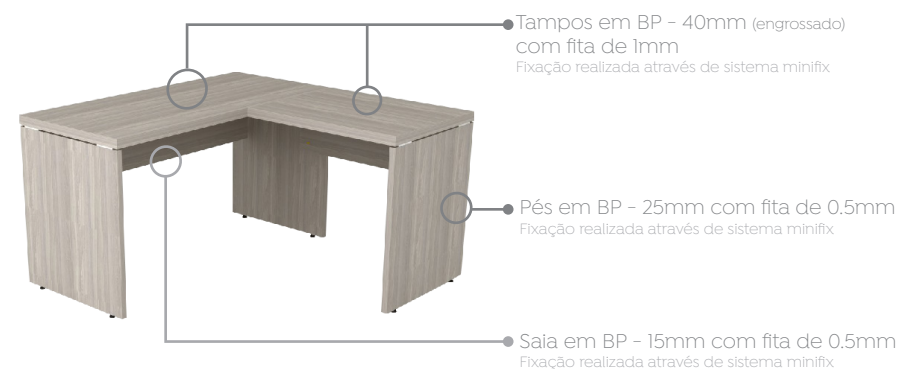

### Mesa Reunião Retangular

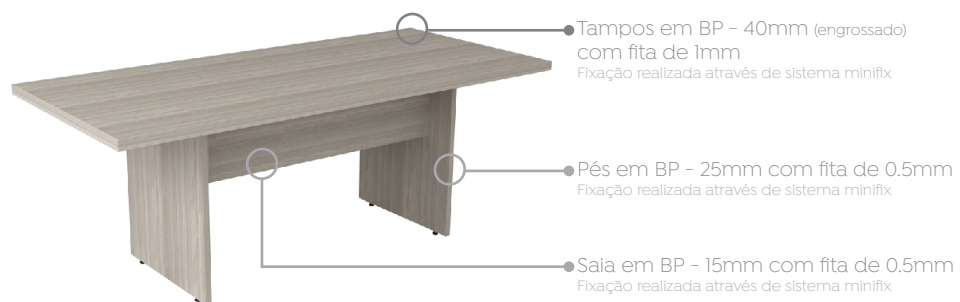

### Mesa Reunião Retangular Bipartida

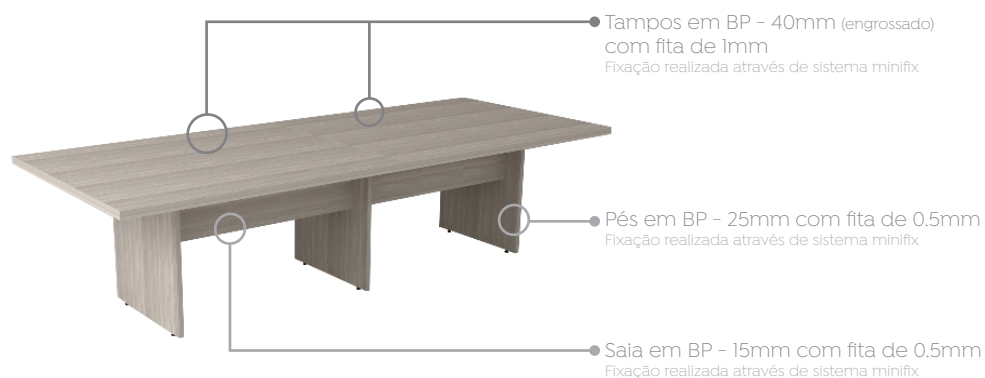

### Caixas de tomada

Mesas Reunião Retangulares possuem opção de rasgo para cx de tomada Basic M.  
Consulte modelos e medidas na tabela de preços



### Mesa Diretiva para Gaveteiro Pedestal

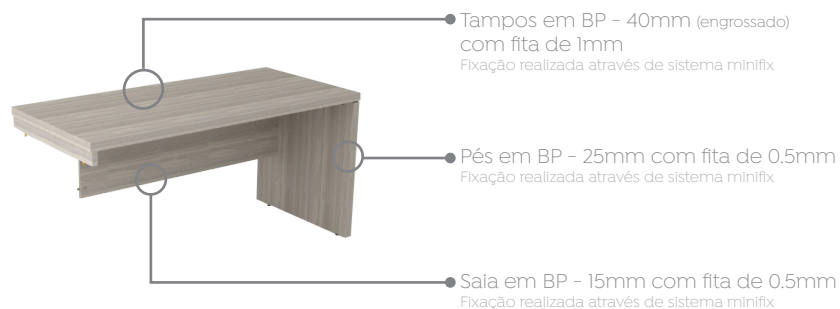

### Mesa Diretiva para Armário

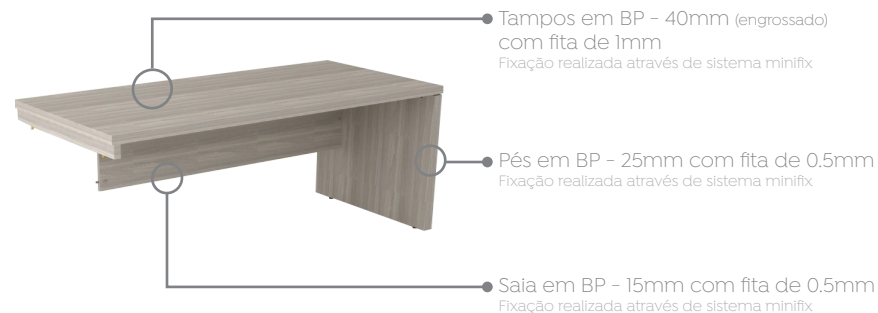

#### Aplicação:

Recomenda-se o uso com Gaveteiros Diretiva



- 1 Mesa Diretiva para Gaveteiro Pedestal
- 2 Gaveteiro Diretiva 2 Gavetas + Pasta

#### Aplicação:

Recomenda-se o uso com Armários Diretiva



- 1 Mesa Diretiva para Armário
- 2 Armário Diretiva porta BP LD Esquerdo





# GAVETEIROS - ARQUIVOS

Sumário (selecione o item) 

Gaveteiros.....	10
Gaveteiro Fixo.....	10
Gaveteiro Pedestal.....	11
Gaveteiro Diretiva.....	12
Gaveteiro Rodízio.....	13
Arquivos.....	14
Arquivo 4 Gavetas Pasta.....	14
Arquivo 4 Gavetas Pasta + Nicho.....	14

## Gaveteiro Fixo

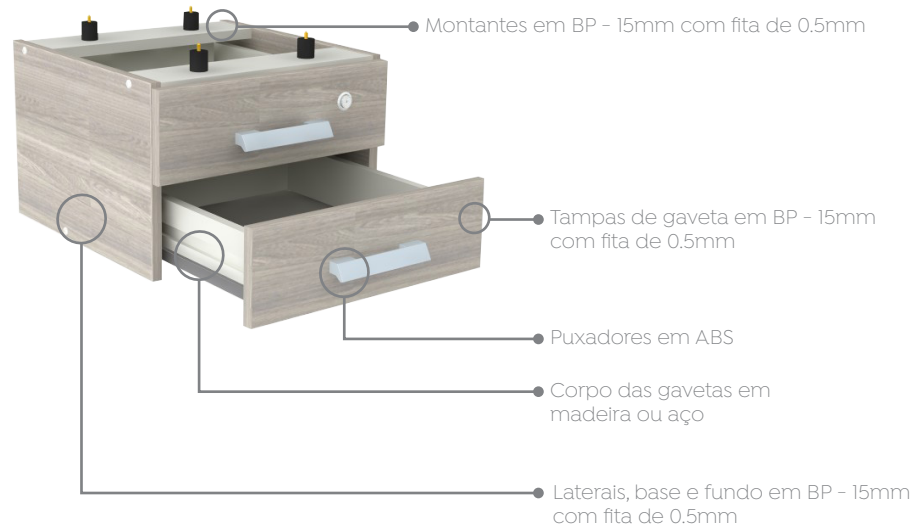

## Modelos:



Gaveteiro Fixo 2 Gavetas  
Gaveta em madeira



Gaveteiro Fixo 2 Gavetas  
Gaveta em aço

## Gaveteiro Pedestal

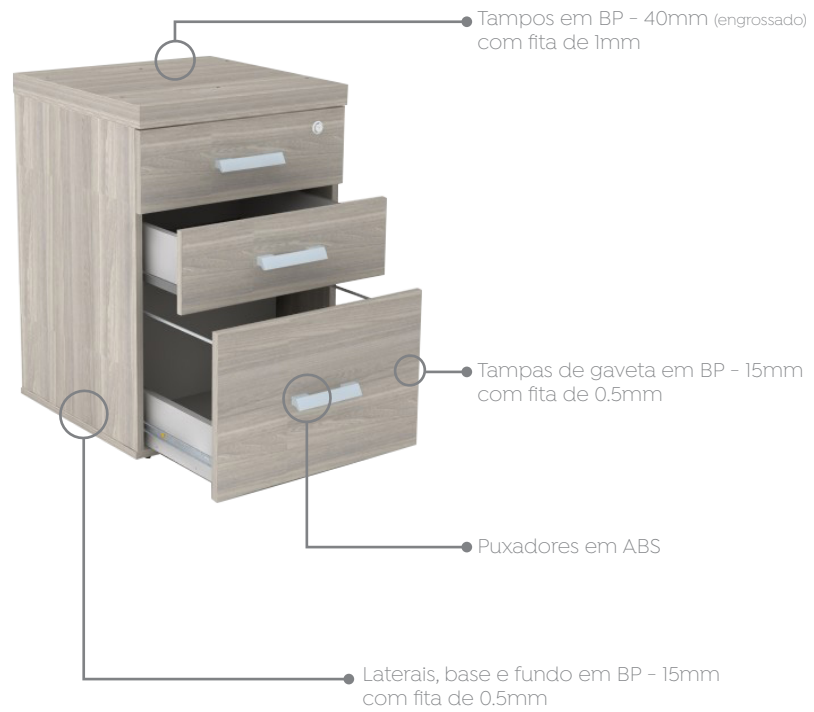

## Modelos:



Gaveteiro Pedestal 4 Gavetas



Gaveteiro Pedestal 2 Gavetas + Pasta

## Gaveteiro Diretiva

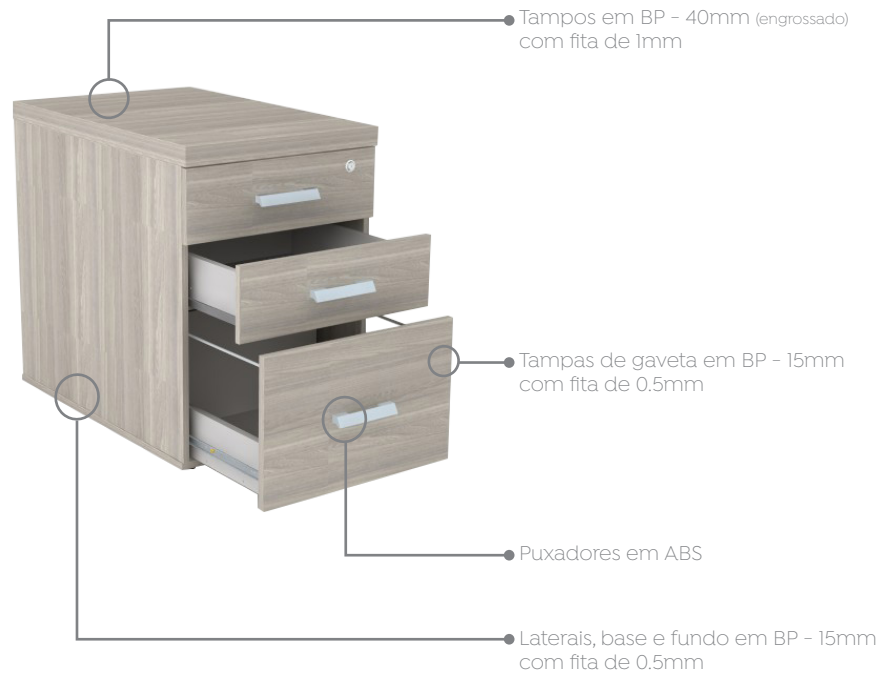

## Modelos:



Gaveteiro Diretiva 4 Gavetas



Gaveteiro Diretiva 2 Gavetas + Pasta

## Gaveteiro Rodízio

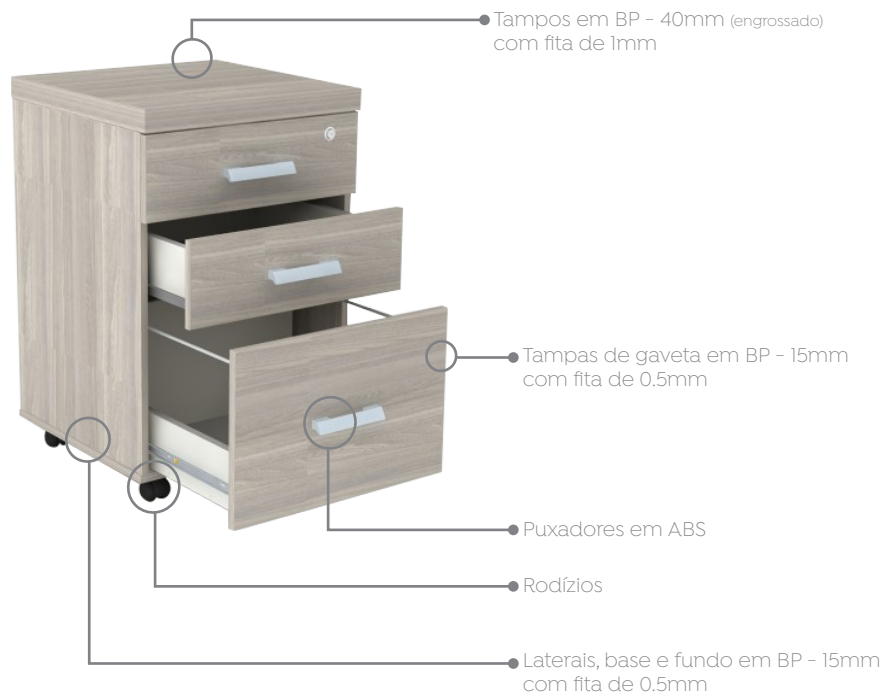

## Modelos:



Gaveteiro Rodízio 4 Gavetas



Gaveteiro Rodízio 2 Gavetas + Pasta

## Arquivos



## Modelos:



Arquivo 4 Gavetas Pasta



Arquivo 4 Gavetas Pasta + Nicho



# ARMÁRIOS

Sumário (selecione o item) 

Armário Baixo.....	17
Armário Baixo Fechado Secretária .....	17
Armário Baixo Creedence.....	17
Armário Baixo Creedence Duplo .....	17
Armário Nicho Porta de Correr.....	17
Armário Nicho Porta de Correr .....	17
Armário Médio.....	18
Armário Médio Fechado .....	18
Armário Alto.....	18
Armário Alto Fechado Diretor .....	18
Armário Alto Executivo .....	18
Armário Alto Charuto Fechado .....	18

<b>Armário Combo</b> .....	19
Armário Combo.....	19
<b>Armário Diretiva</b> .....	20
Armário Diretiva Porta BP.....	20
Armário Diretiva c/ Abertura p/ Porta.....	20
<b>Armário Nicho</b> .....	21
Armário Nicho Porta BP.....	21
Armário Nicho Sem Porta.....	21
Armário Complemento Porta Basculante.....	22





## Armário Baixo Fechado Secretária - Fundo 3mm



## Armário Baixo Credence Duplo - Fundo 3mm

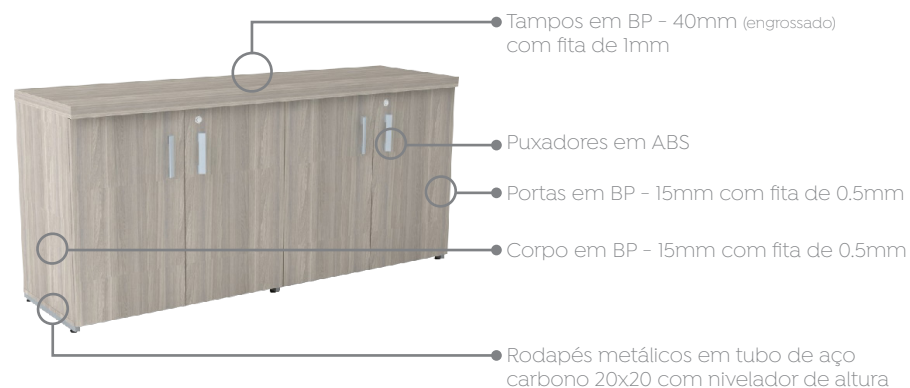

## Armário Baixo Credence - Fundo 15mm

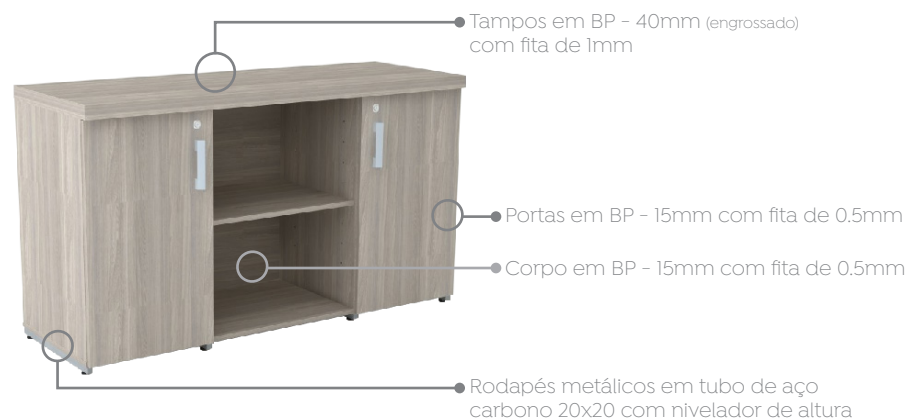

## Armário Nicho Porta de Correr - Fundo 15mm

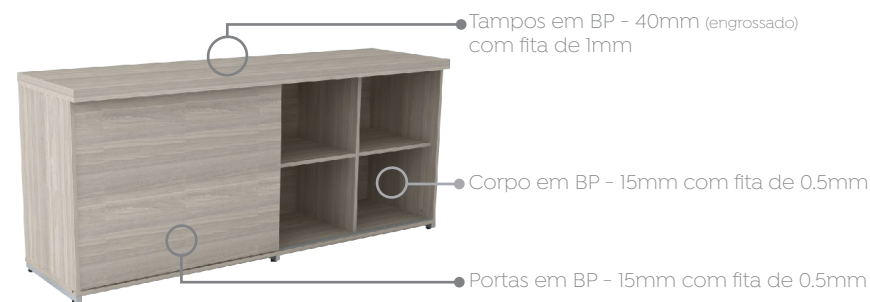

## Armário Médio Fechado - Fundo 3mm

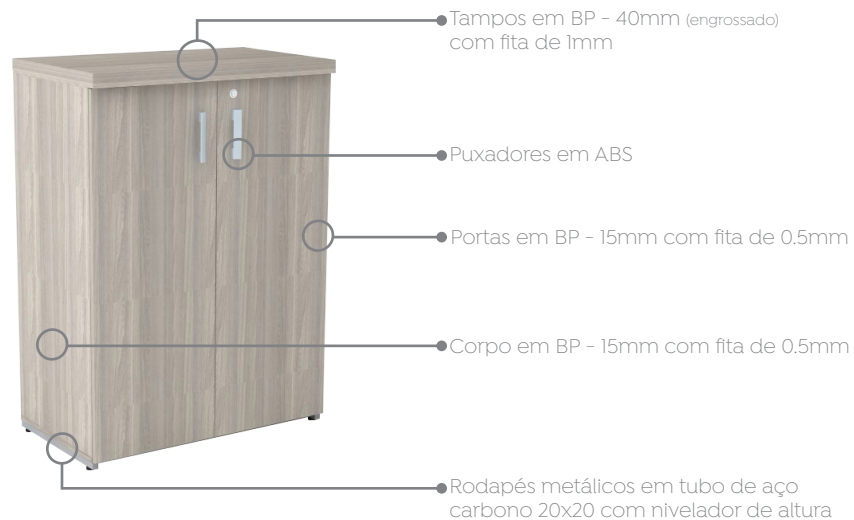

## Armário Alto Fechado Diretor - Fundo 3mm

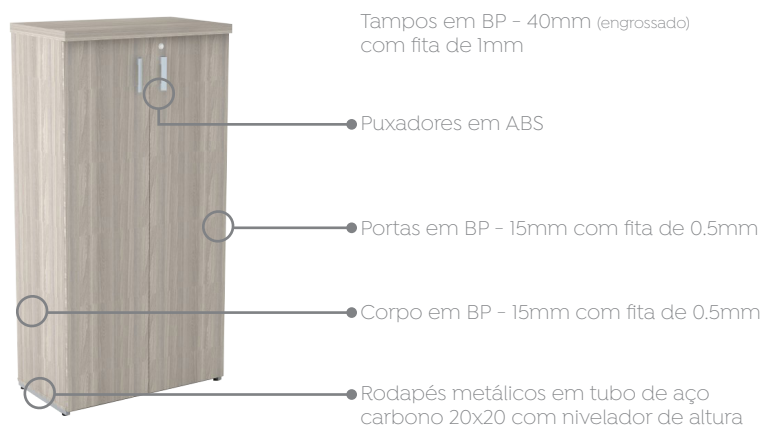

## Armário Alto Executivo - Fundo 3mm

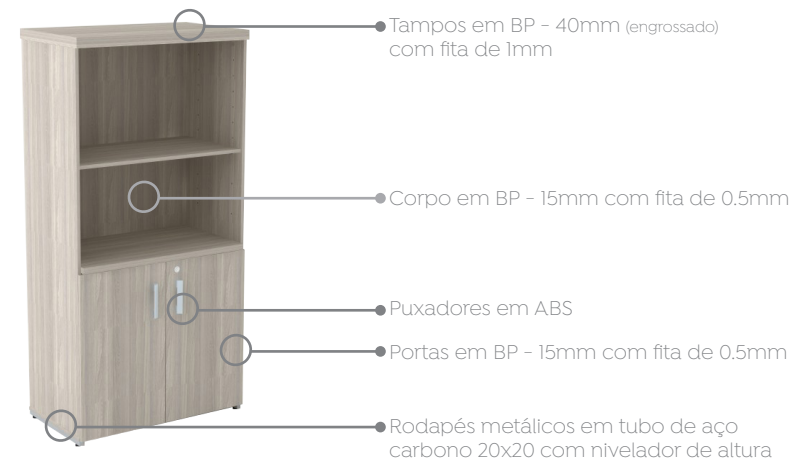

## Armário Alto Charuto Fechado - Fundo 3mm



## Armário Combo

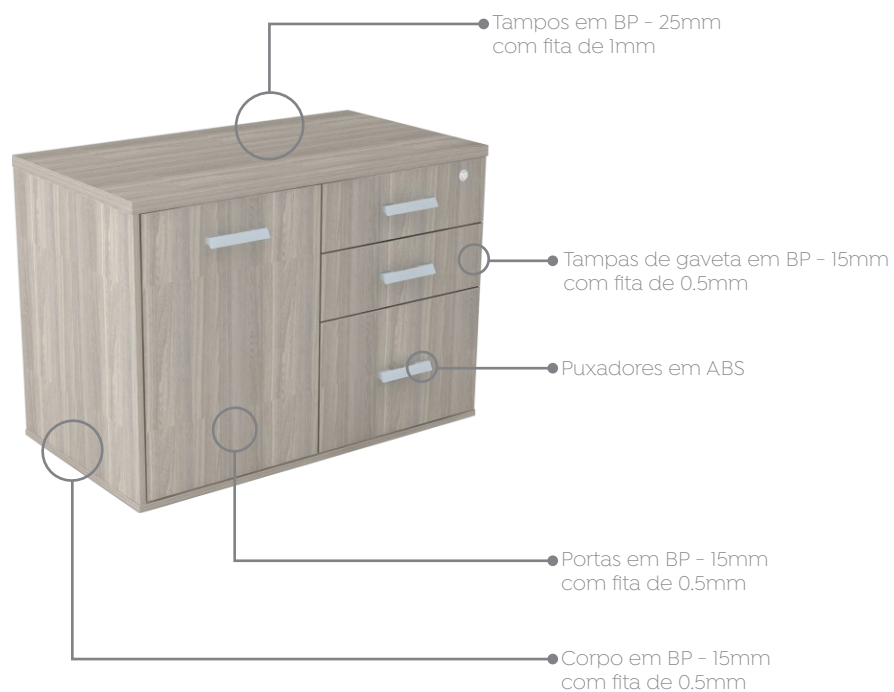

## Modelos:



Armário Combo Porta Ld Esq 4 Gav



Armário Combo Porta Ld Esq 2 Gav + Pasta



Armário Combo Porta Ld Dir 4 Gav



Armário Combo Porta Ld Dir 2 Gav + Pasta

## Armário Diretiva Porta BP

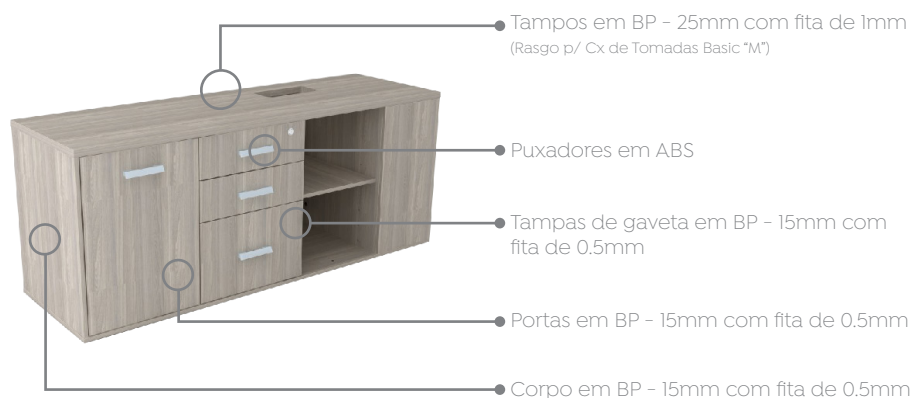

### Modelos:



Armário Diretiva Porta BP Ld Esq



Armário Diretiva Porta BP Ld Dir

## Armário Diretiva c/ Abertura p/ Porta

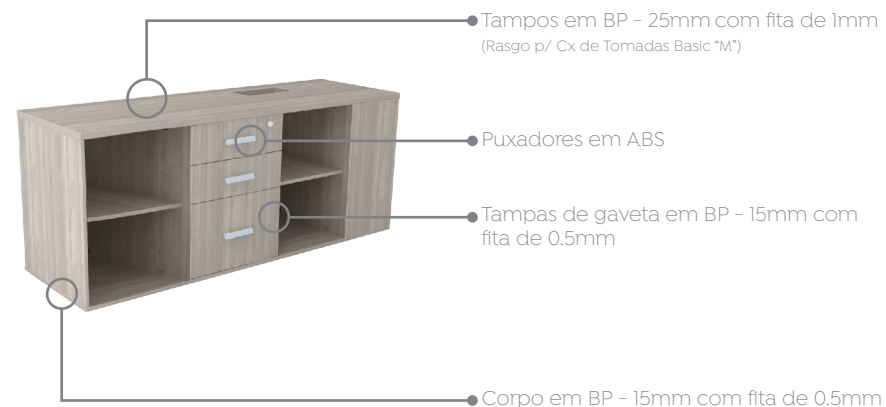

### Modelos:



Armário Diretiva Abertura p/ Porta Ld Esq



Armário Diretiva Abertura p/ Porta Ld Dir

Armário Nicho Porta BP

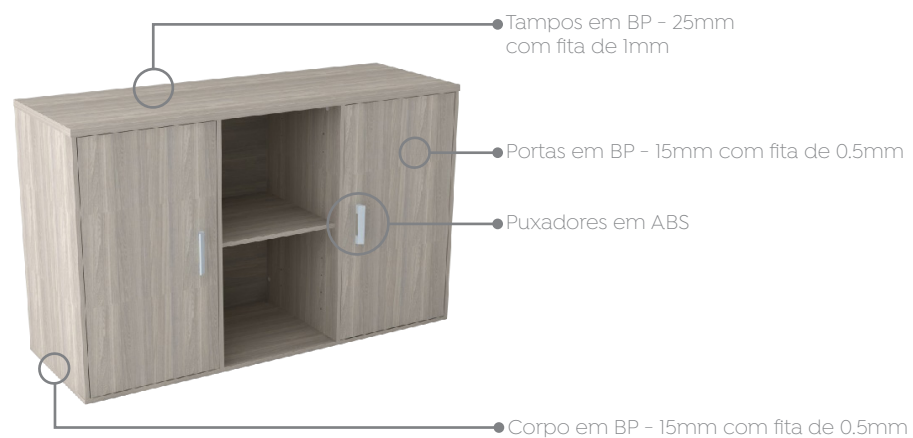

Modelos:



Armário Nicho Porta BP 140



Armário Nicho Porta BP 160

Armário Nicho Sem Porta



Modelos:



Armário Nicho Sem Porta 140



Armário Nicho Sem Porta 160

## Armário Complemento Porta Basculante

Prima Impact



### Aplicação:

Recomenda-se o uso com Armários Nicho 160



- ① Armário Complemento Porta Basculante
- ② Armário Nicho Porta BP 160



- ① Armário Complemento Porta Basculante
- ② Armário Nicho Porta Vidro 160



# PLATAFORMAS

Sumário (selecione o item) 

Plataformas .....	24
Plataforma Simples Módulo Central/Supervisor.....	24
Plataforma Simples Módulo Auxiliar.....	24
Plataforma Dupla Módulo Central.....	24
Plataforma Dupla Módulo Auxiliar.....	24

## Plataforma Simples Módulo Central / Módulo Supervisor

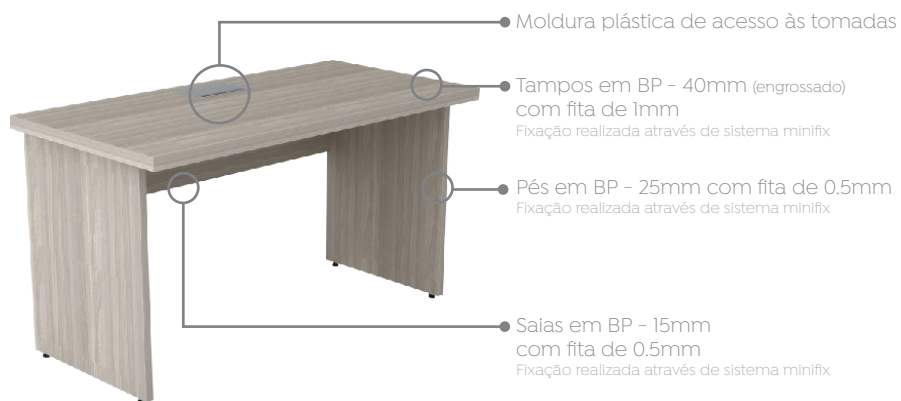

## Plataforma Dupla Módulo Central

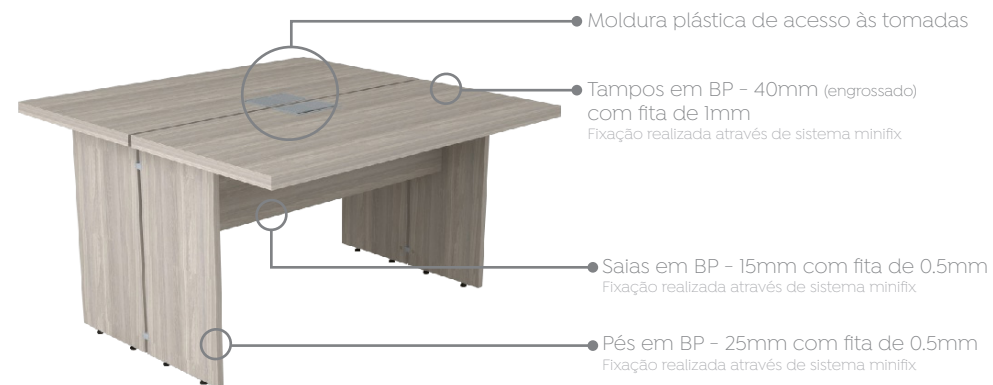

## Plataforma Simples Módulo Auxiliar

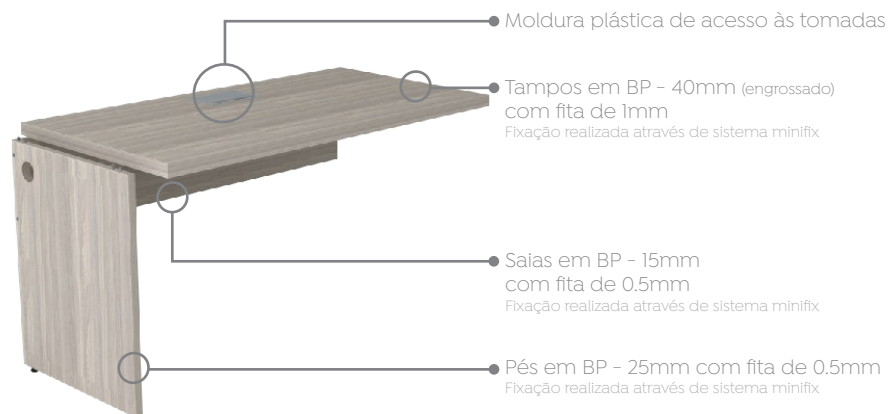

## Plataforma Dupla Módulo Auxiliar

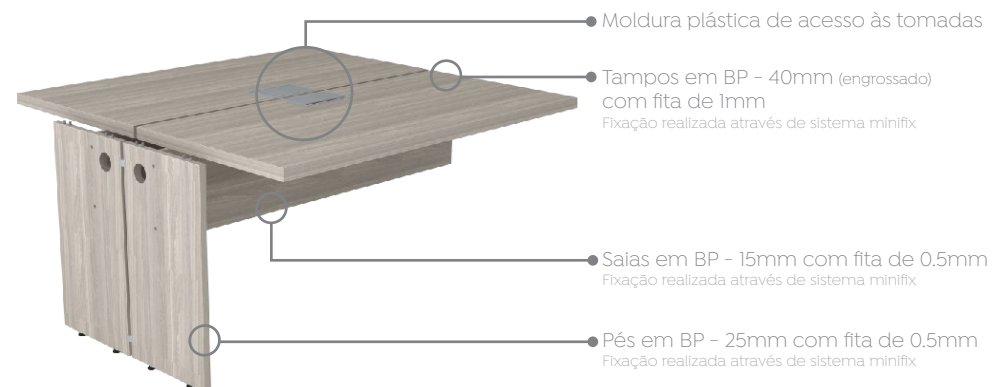



## Montagem de módulos

### Plataforma Dupla 4 lugares



- 1 Módulo Central Plataforma Dupla
- 2 Módulo Auxiliar Plataforma Dupla

 O procedimento para montagem de módulos é igual para Plataformas Simples e Plataformas Duplas.

### Sistema de montagem

**1.** Solte um dos pés do Módulo Central (pode ser qualquer um dos lados).

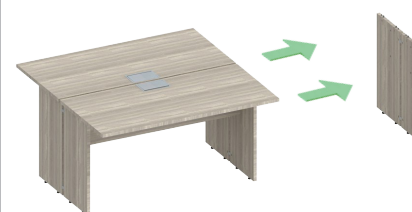

**2.** Acrescente o Módulo Auxiliar e fixe-o no lugar onde estava o pé lateral retirado no passo anterior.



**3.** Com o Módulo Auxiliar devidamente fixado, faça o fechamento da plataforma com o pé lateral que foi solto no 1º passo.



**4.** Fixe todos os parafusos para finalizar a montagem.



**Obs:** Se for necessário inserir mais módulos, antes de fazer o fechamento deve-se repetir o 2º passo até atingir a quantidade de lugares desejada.



## COMPLEMENTOS

Sumário (selecione o item) 

<b>Biombos</b> .....	27
Biombo Divisor Lateral Plataforma.....	27
<b>Conexões</b> .....	27
Conexão Quadrada com Pé Tubular.....	27
<b>Tampos</b> .....	27
Tampo Junção.....	27
Tampo Auxiliar para Gaveteiro Pedestal.....	28
Tampo Auxiliar para Armário Combo.....	28
Tampo Vidro.....	28
Tampo Vidro com Distanciador.....	28
<b>Portas em Vidro</b> .....	29
Portas em Vidro para Armário Diretiva.....	29
Portas em Vidro para Armário Nicho.....	29
<b>Painel de TV</b> .....	31
Painel de TV sem Passa Fio Veio Horizontal.....	31
Painel de TV com Passa Fio Veio Horizontal.....	31
Painel de TV com Passa Fio Veio Vertical.....	31

[www.mebmoveis.com.br](http://www.mebmoveis.com.br)

### Biombo Divisor Lateral Plataforma

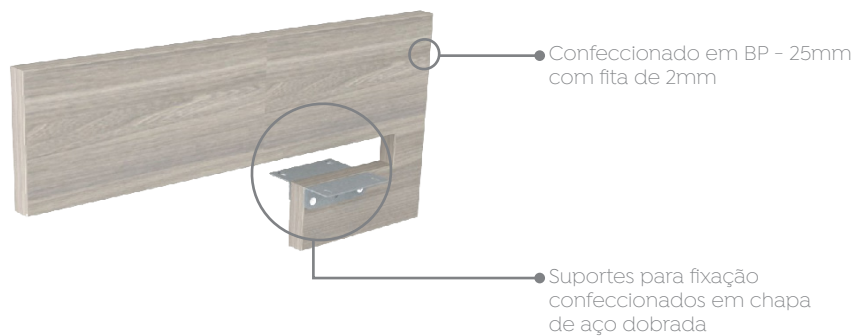

### Conexão Quadrada com Pé Tubular

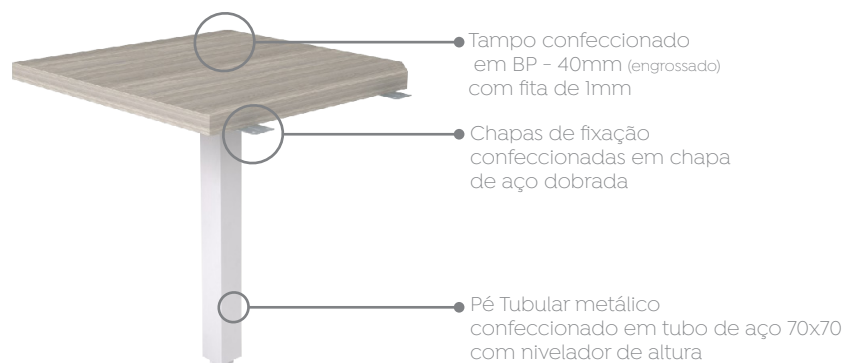

### Tampo Junção

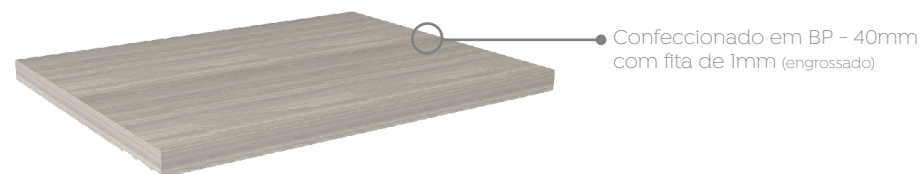

### Modelos:



Tampo Junção Armário



Tampo Junção Gaveteiro

### Tampo Auxiliar p/ Gaveteiro Pedestal



### Tampo Auxiliar p/ Armário Combo



### Tampo Vidro

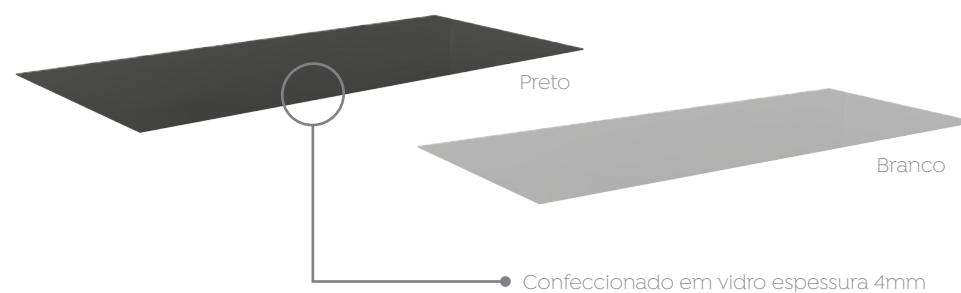

### Tampo Vidro c/ Distanciador

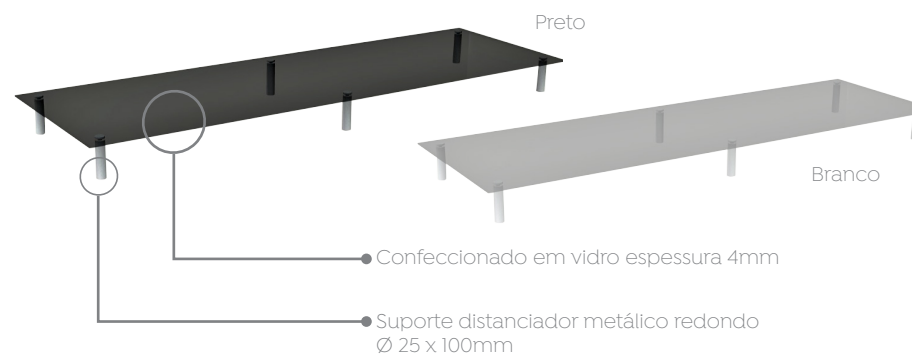

### Portas em Vidro para Armário Diretiva

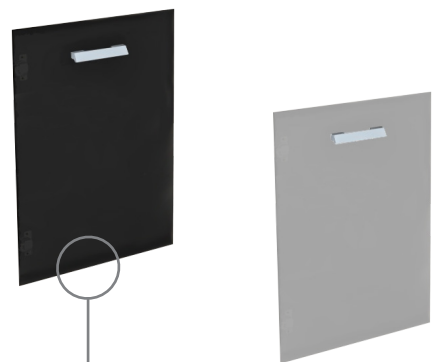

• Confeccionado em vidro espessura 4mm

### Portas em Vidro para Armário Nicho



• Confeccionado em vidro espessura 4mm

## Aplicação Tampos Auxiliares :



- 1 Tampo Auxiliar para Gaveteiro Pedestal Prima Impact
- 2 Gaveteiro Pedestal 4 Gavetas Prima Impact



- 1 Tampo Auxiliar para Armário Combo Prima Impact
- 3 Armário Combo Porta LD Esq 2 Gavetas + Pasta Prima Impact

## Aplicação Tampos de Vidro :



- 1 Tampo Vidro com Distanciador Prima Impact
- 2 Gaveteiro Pedestal 4 Gavetas Prima Impact



- 1 Tampo Vidro Prima Impact
- 2 Tampo Auxiliar para Armário Combo Prima Impact
- 3 Armário Combo Porta LD Esq 2 Gavetas + Pasta Prima Impact



- 1 Tampo Vidro Prima Impact (\* verificar medidas disponíveis)
- 2 Mesa Diretor Prima Impact
- 3 Tampo Auxiliar para Gaveteiro Pedestal Prima Impact
- 4 Gaveteiro Pedestal 2 Gavetas + Pasta Prima Impact

**Painel de TV Sem Passa Fio Veio Horizontal**

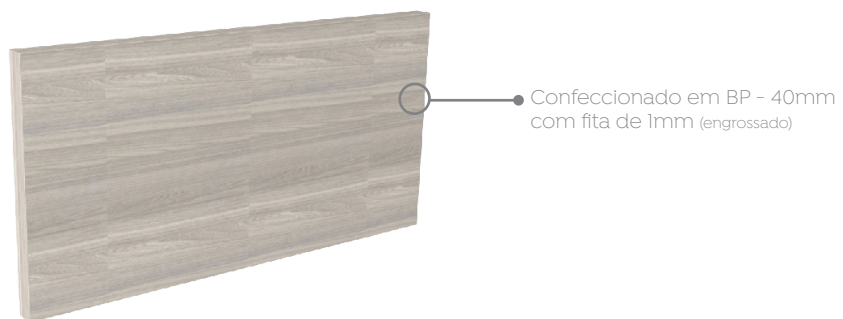

**Painel de TV Com Passa Fio Veio Horizontal**



**Painel de TV Com Passa Fio Veio Vertical**

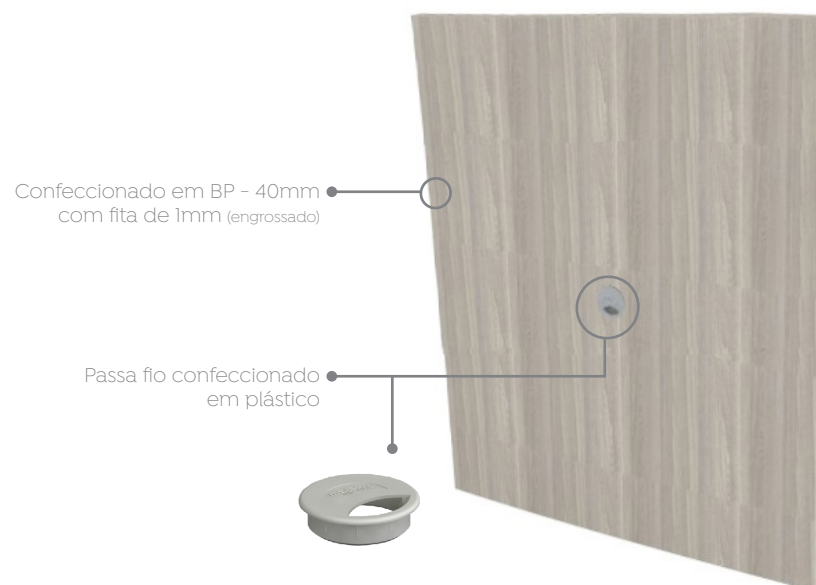







[www.mebmoveis.com.br](http://www.mebmoveis.com.br)