







e-Book

Call Center

MÓVEIS CORPORATIVOS

Call Center

 Seleccione o tópico:

 CORES.....	03
 MÓDULOS.....	04
 COMPONENTES.....	09
 EXEMPLOS DE MONTAGENS.....	21
 CERTIFICADOS.....	23

Cores disponíveis

Madeiras



02-CRISTAL



03-OVO



05-PRETO

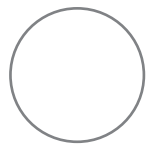

07-BRANCO



06-ARGILA



15-CARVALHO
PRATA



18-NOCE MONZA



25-LANARCA

Metálicos



02-CRISTAL



03-OVO



05-PRETO



06-ARGILA

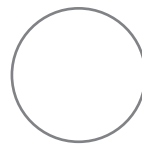

07-BRANCO

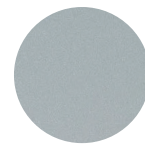

12-ALUMÍNIO

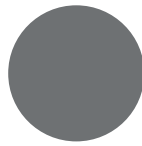

16-GRAFITE



Instrução de Cores

Módulo Lateral:

COR 1 - Laterais e Fundo
COR 2 - Metálicos

Módulo Central:

COR 1 - Laterais e Fundo
COR 2 - Metálicos

Tampos:

COR 1 - Todas as peças

Abafadores:

COR 1 - Tecido*

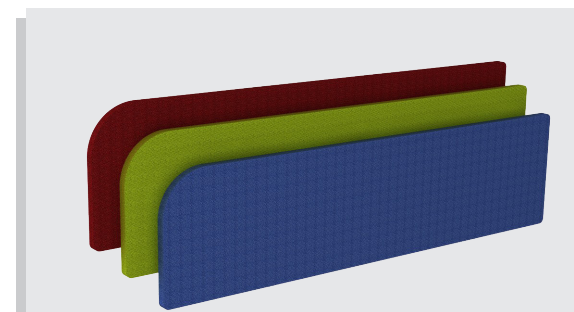

*Para informações sobre cores disponíveis para os abafadores consulte a cartela de cores para tecido





MÓDULOS

Sumário

Módulos - Visão geral.....	05
Módulo Abafador Curvo.....	05
Módulo Abafador Reto.....	05
Módulo Tampos.....	05
Módulo Tampos com Perfil 180°	05
Módulo Lateral Simples Reto.....	06
Módulo Lateral Simples Curvo.....	06
Módulo Lateral Duplo Reto.....	06
Módulo Lateral Duplo Curvo.....	06
Módulo Central Simples Reto.....	07
Módulo Central Simples Curvo.....	07
Módulo Central Duplo Reto.....	07
Módulo Central Duplo Curvo.....	07
Sistema de montagem.....	08

Call Center

www.mebmoveis.com.br

 VOLTAR AO INÍCIO



Módulos - Visão geral

Módulo Abafador Curvo

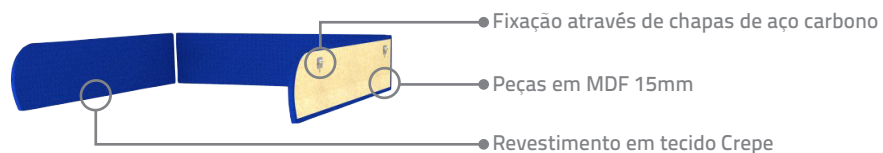

* Consultar cartela de cores para tecido

Módulo Abafador Reto

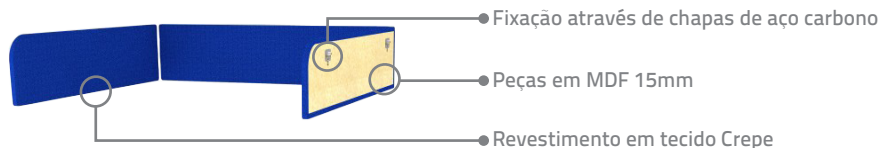

* Consultar cartela de cores para tecido



Módulo Tampos

Com consulta e sem consulta

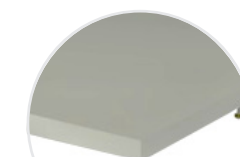
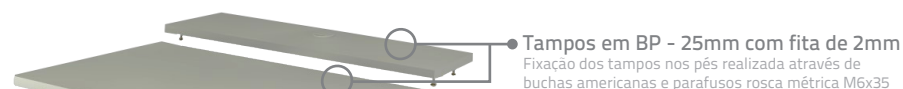

Opção fita de 2mm em todas as faces

 Opção de dimensões para versão "Com Consulta" ou "Sem Consulta"

Módulo Tampos com Perfil 180°

Com consulta e sem consulta

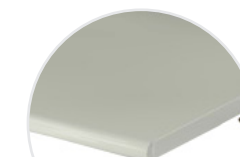
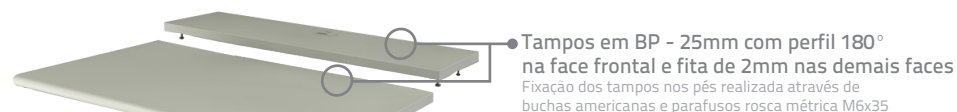

Opção face frontal com perfil 180°

Cores Disponíveis:



 Opção de dimensões para versão "Com Consulta" ou "Sem Consulta"

Módulos - Visão geral

Módulo Lateral Simples Reto

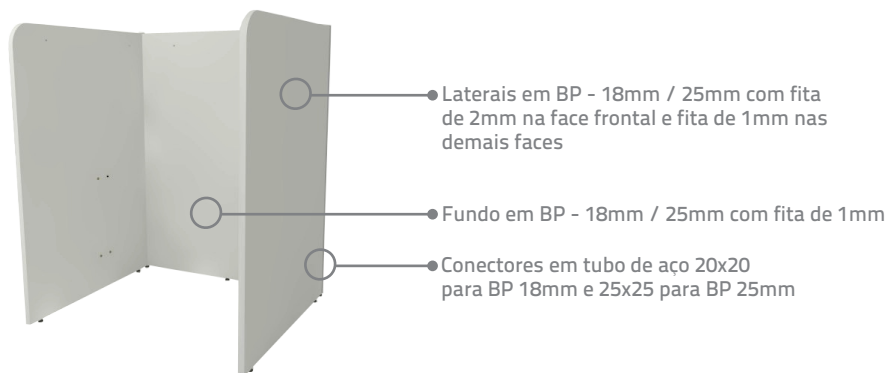

Opção com ou sem furação para abafadores

Módulo Lateral Simples Curvo

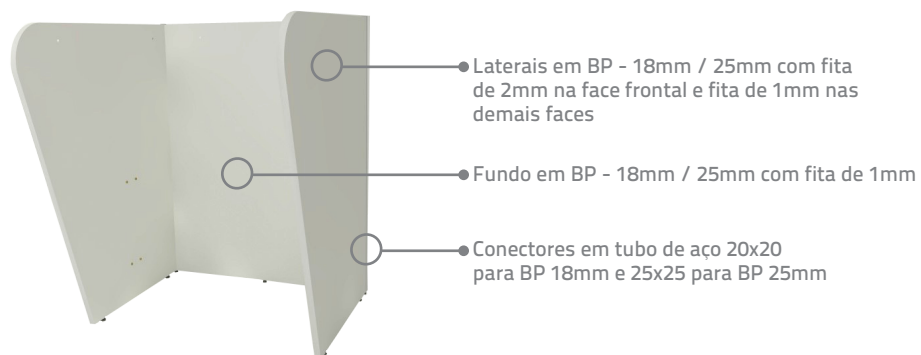

Opção com ou sem furação para abafadores

Módulo Lateral Duplo Reto

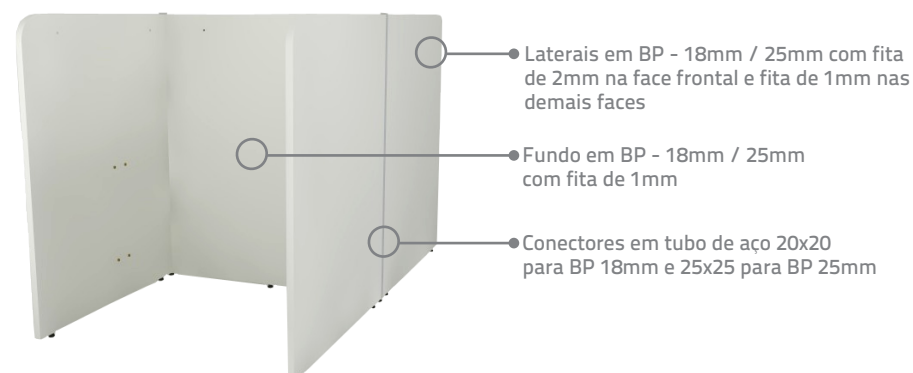

Opção com ou sem furação para abafadores

Módulo Lateral Duplo Curvo

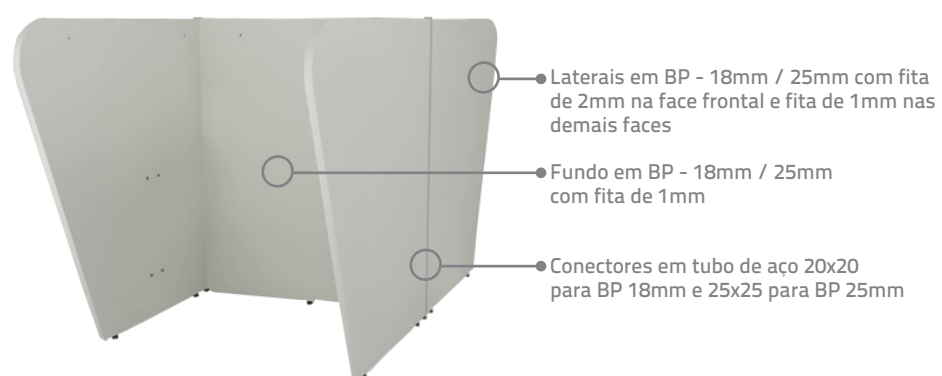

Opção com ou sem furação para abafadores

Módulos - Visão geral

Módulo Central Simples Reto

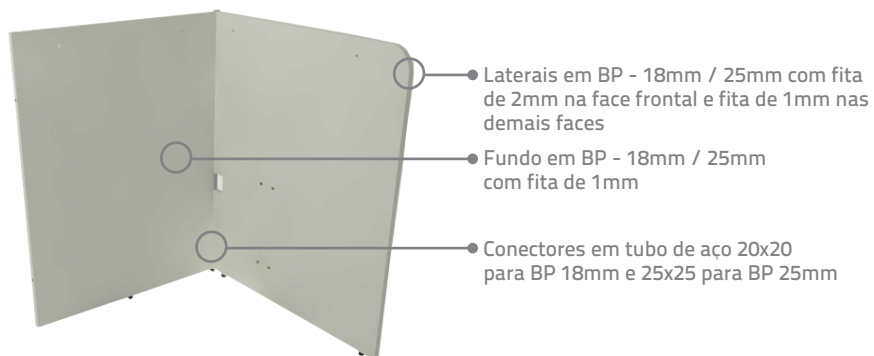

 Opção com ou sem furação para abafadores

Módulo Central Simples Curvo

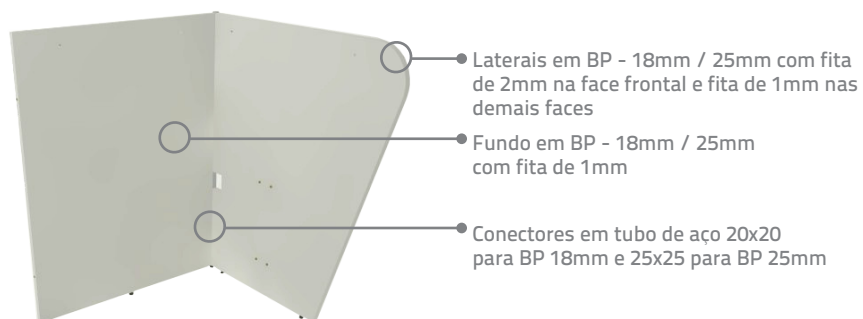

 Opção com ou sem furação para abafadores

Módulo Central Duplo Reto

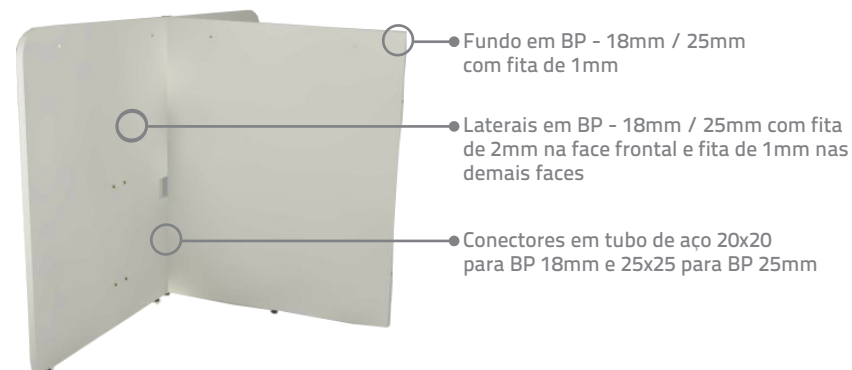

 Opção com ou sem furação para abafadores

Módulo Central Duplo Curvo

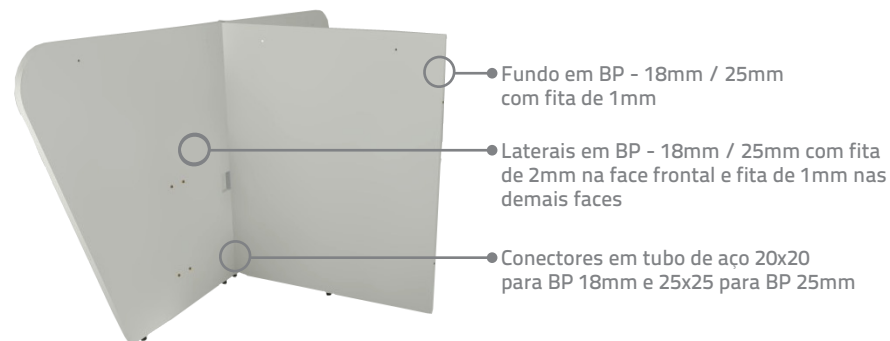

 Opção com ou sem furação para abafadores

Exemplos de montagens



- ① Módulo Lateral Duplo Curvo
- ② Módulo Central Duplo Curvo
- ③ Módulo de Tampo c/ perfil 180°
- ④ Conjunto Estrutura Call Center com Base Tubular

Sistema de montagem

1. Solte as laterais de um dos lados do Módulo Lateral.

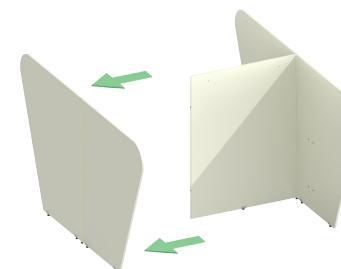

2. Acrescente o Módulo Central fixando-o com o conector tubular

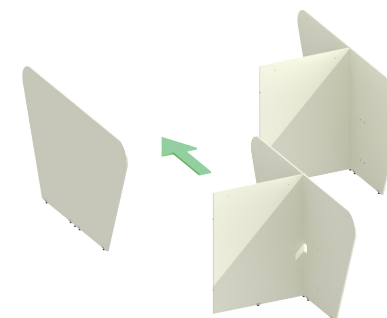

3. Com o Módulo Central devidamente fixado, faça o fechamento da Estação com a lateral que foi solta no 1º passo.

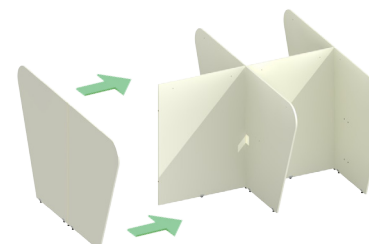

4. Faça a fixação dos Módulos com os conectores, e acrescente as estruturas metálicas e tampo.

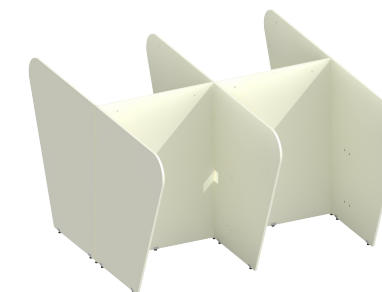

Obs: Se for necessário inserir mais módulos, antes de fazer o fechamento deve-se repetir o 2º passo até atingir a quantidade de lugares desejada.



COMPONENTES

Sumário

Componentes - Visão geral.....	10
Abafadores.....	10
Laterais Retas.....	11
Laterais Curvas.....	12
Fundos.....	13
Conectores.....	14
Estruturas.....	15
Dimensões da Estrutura.....	16
Ergonomia.....	17
Sistema de Eletrificação.....	19
Modelos de Calha.....	20
Tomadas e Conectores.....	21



Call Center

www.mebmoveis.com.br

 VOLTAR AO INÍCIO

Componentes - Visão geral

Abafadores

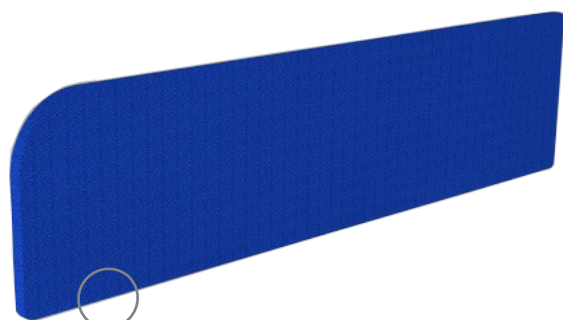

Peça em MDF 15mm c/ revestimento em tecido tipo Crepe
Fixação realizada através de chapas de aço carbono



Detalhe das chapas para fixação

Modelos:

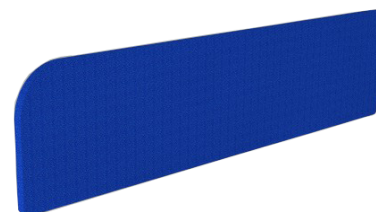

Abafador Lateral Reto



Abafador Lateral Curvo

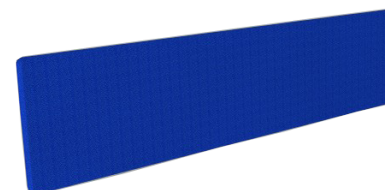

Abafador Fundo

Componentes - Visão geral

Laterais Retas



Laterais em BP - 18mm / 25mm com fita de 2mm na face frontal e fita de 1mm nas demais faces

 Opção com ou sem furação para abafadores

Modelos:



Lateral Retas Direita



Lateral Retas Esquerda



Lateral Retas Central

Componentes - Visão geral

Laterais Curvas



• Laterais em BP - 18mm / 25mm com fita de 2mm na face frontal e fita de 1mm nas demais faces

 Opção com ou sem furação para abafadores

Modelos:



Lateral Curva Direita



Lateral Curva Esquerda



Lateral Curva Central

Componentes - Visão geral

Fundos



● Fundos em BP - 18mm / 25mm
com fita de 1mm

Modelos:



Fundo Simples com furação
para Abafador



Fundo Duplo com furação
para Abafador



Fundo sem furação para Abafador

Componentes - Visão geral

Conectores



Modelos:

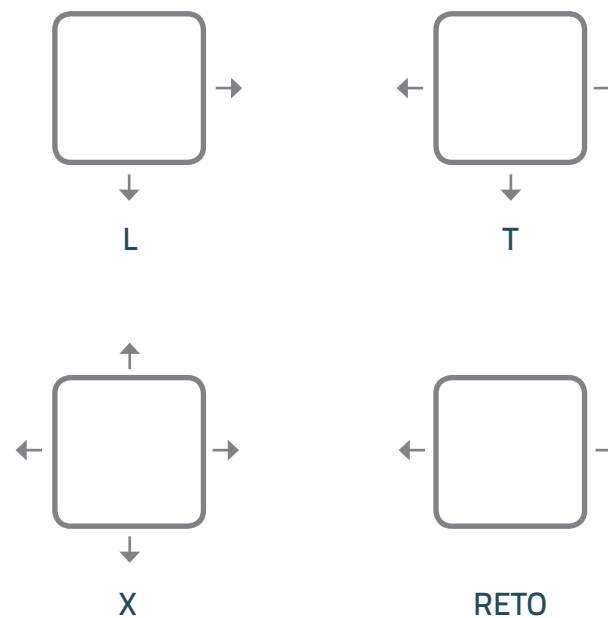

 *As setas indicam as faces com furação para cada modelo

Componentes - Visão geral

Estruturas

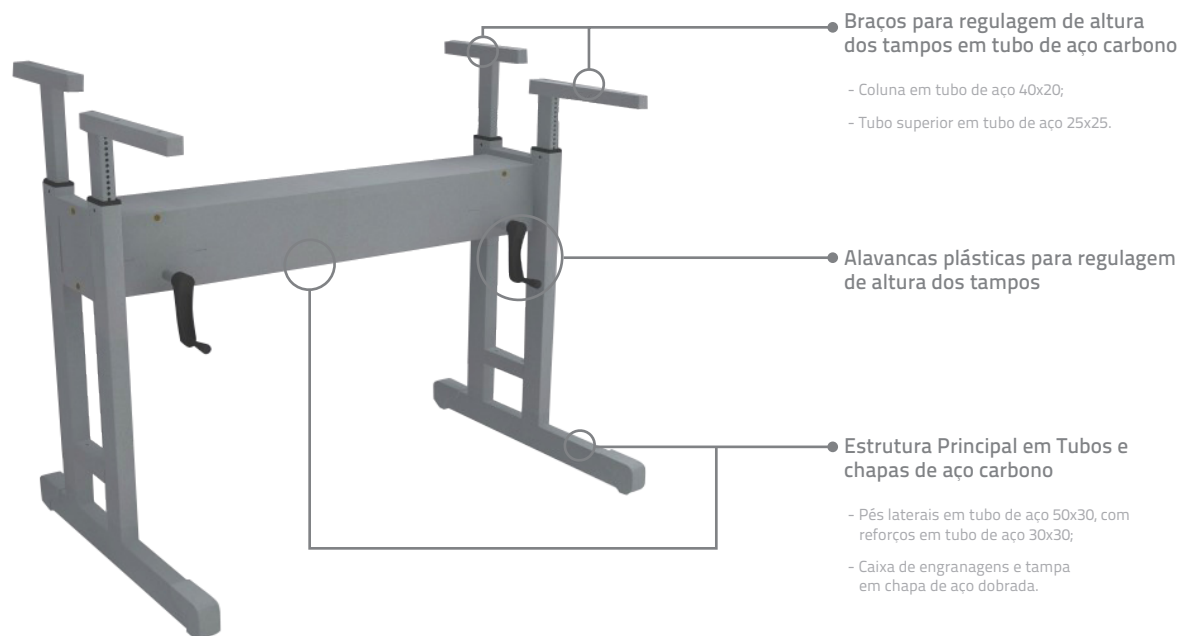

Modelos:



Conjunto Estrutura Call Center sem Base



Conjunto Estrutura Call Center com Base Tubular

Dimensões da Estrutura

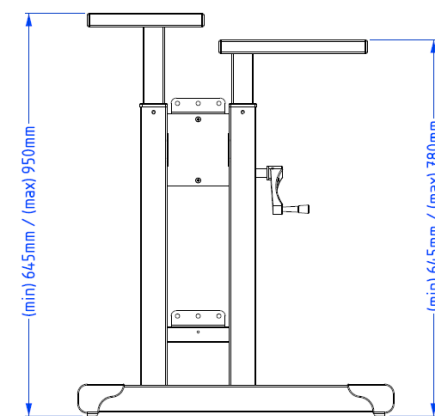
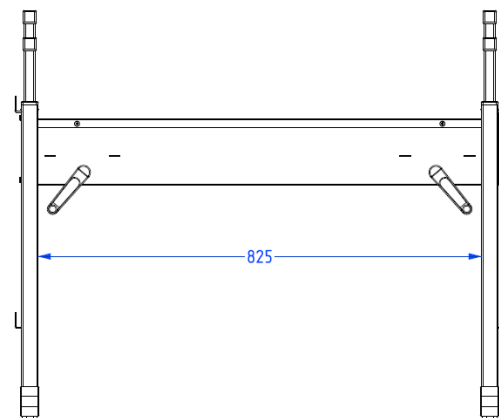

Dimensões

Dimensões	min	max
Largura livre para as pernas	825	
Altura da superfície de trabalho para o teclado (NBR-15786:2010)	645	780
Altura da superfície de trabalho para o monitor (NBR-15786:2010)	645	950
Profundidade livre para os joelhos	450	[---]
Profundidade livre para os pés	700	[---]

* valores em milímetros

Ergonomia

A altura dos tampos pode ser regulada de acordo com a estatura de cada pessoa:



Alturas dos tampos

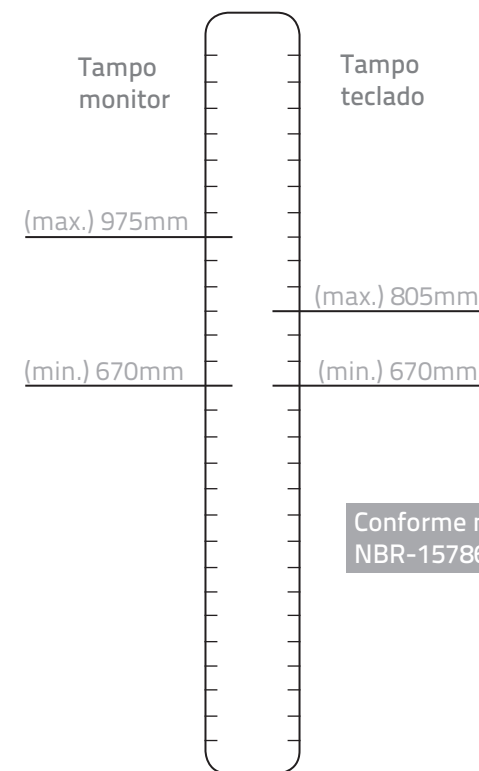

Exemplos de montagens



Estrutura c/ Base Tubular



Estrutura s/ Base

Sistema de Eletrificação



Calhas Berço modelo "J", modelo com tampa e modelo caixa são utilizadas para eletrificação dos módulos de Call Center.

- Calhas vendidas separadamente
- Plugs de tomadas e Rj não inclusos



Calhas metálicas para eletrificação

As calhas suportam elétrica, dados e voz



Modelos de calha:

Calha berço modelo "J"

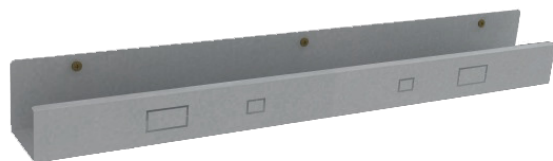

Perfil:

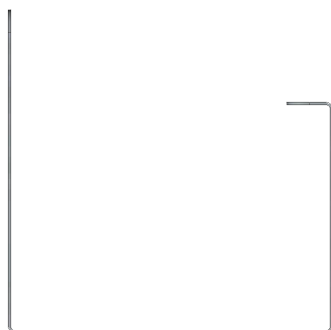

Calha com tampa



Perfil:

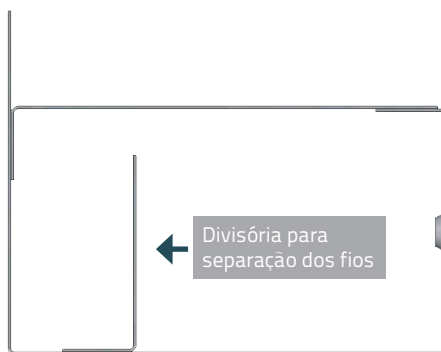

Calha modelo caixa



Perfil:

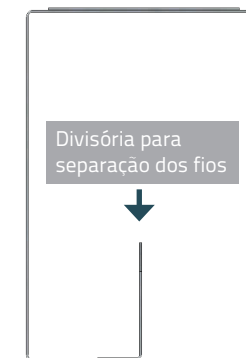

Tomadas e Conectores

 *Tomadas e Conectores não inclusos

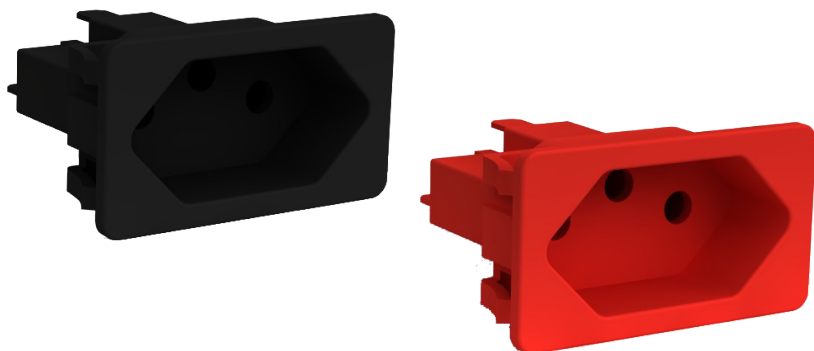

Tomada Margirius poço interno 3 condutores

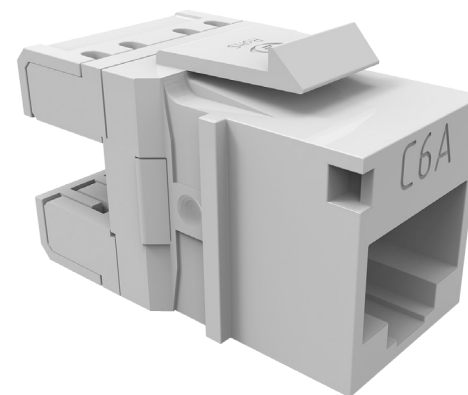
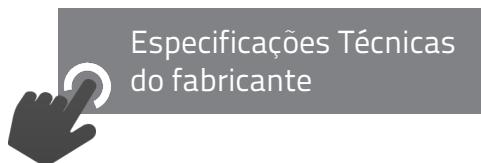

Conector RJ-45 Fêmea (Keystone Jack) Furuwawa

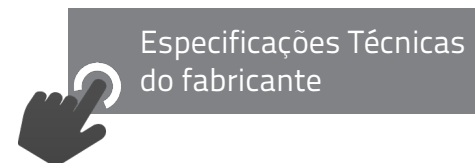



● Fiação dados ● Fiação voz ● Fiação elétrica

Call Center

Exemplos de montagens



- ① Módulo Lateral Duplo Curvo
- ② Módulo Central Duplo Curvo
- ③ Módulo Abafador Curvo
- ④ Módulo de Tampos c/ perfil 180°
- ⑤ Conjunto Estrutura Call Center com Base Tubular

Call Center

Exemplos de montagens



- ① Módulo Lateral Simples Reto
- ② Módulo Central Simples Reto
- ③ Módulo Abafador Reto
- ④ Módulo de Tampos
- ⑤ Conjunto Estrutura Call Center com Base Tubular



www.mebmoveis.com.br